

4048 Precast Trench

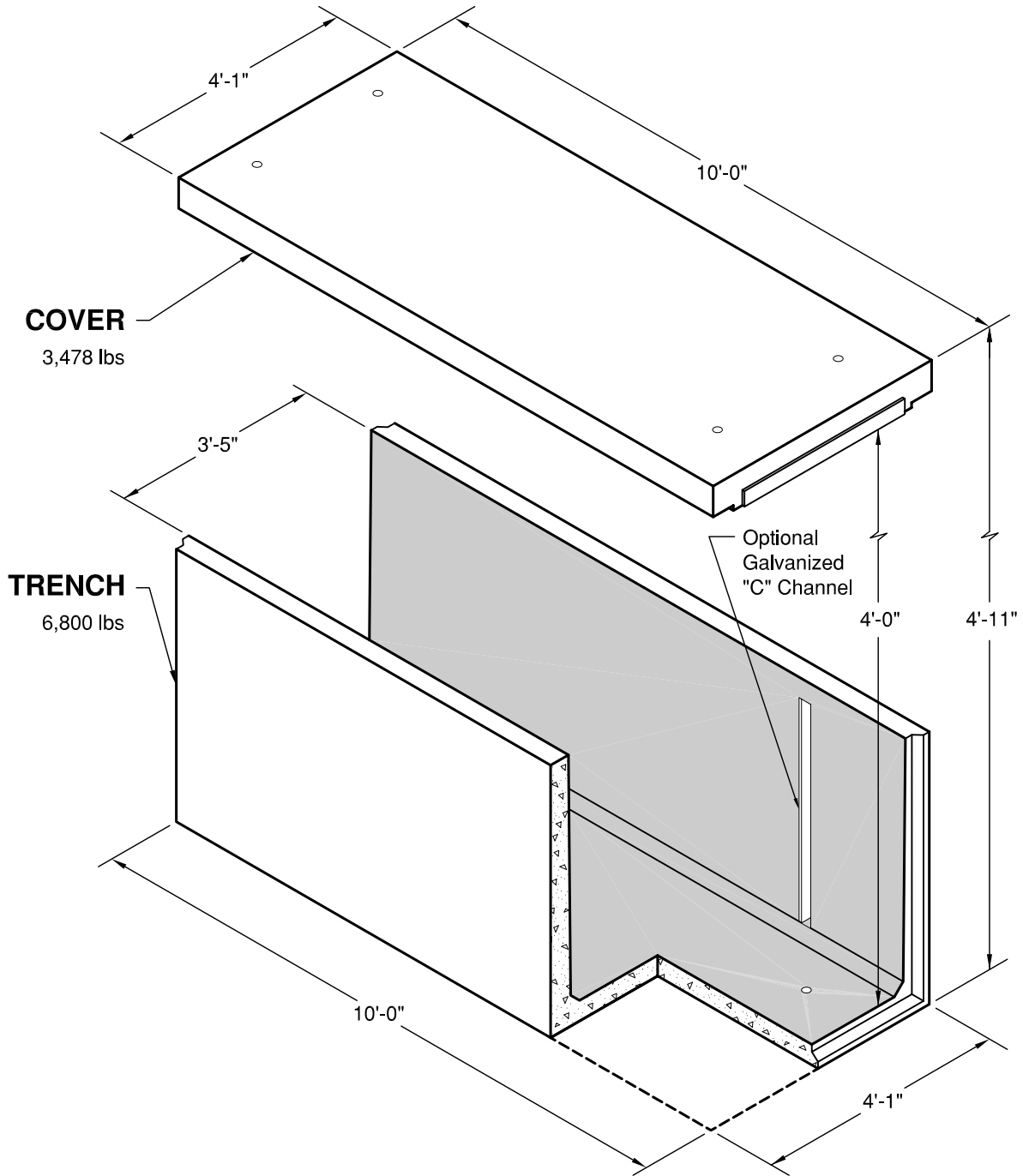

GRANITE

**PRECASTING &
CONCRETE INC.**

4048 Precast Trench

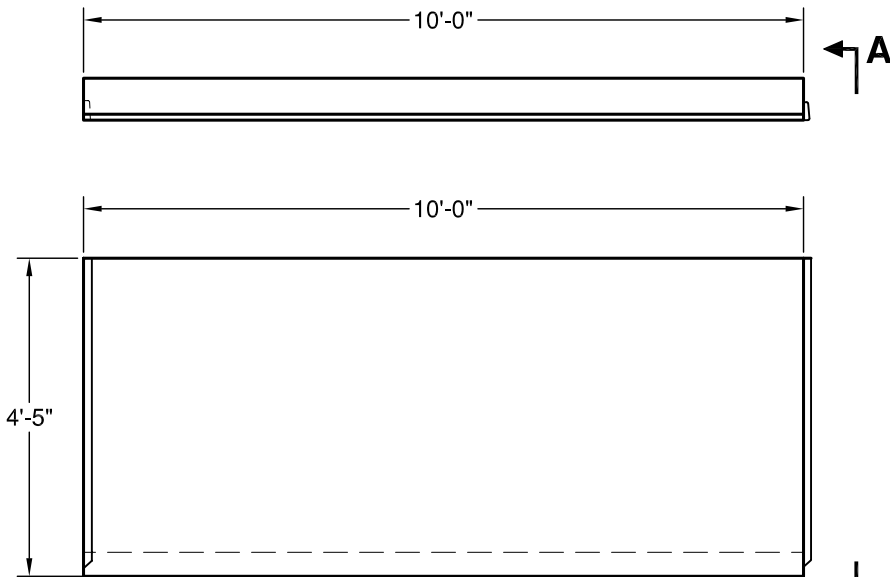

ELEVATION BB

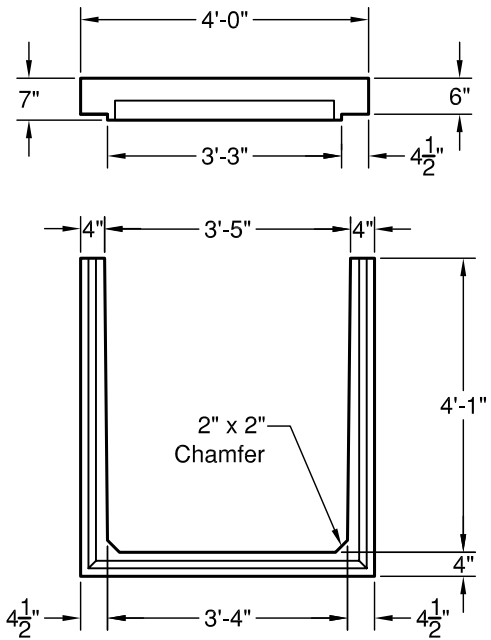

ELEVATION AA

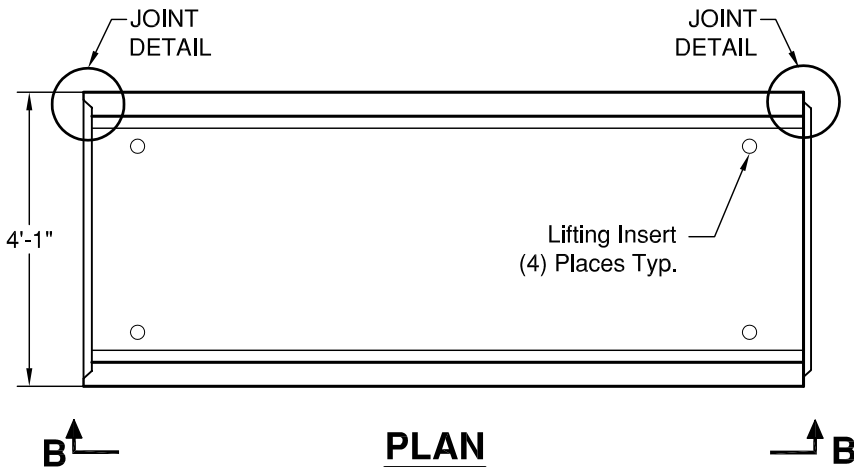

PLAN

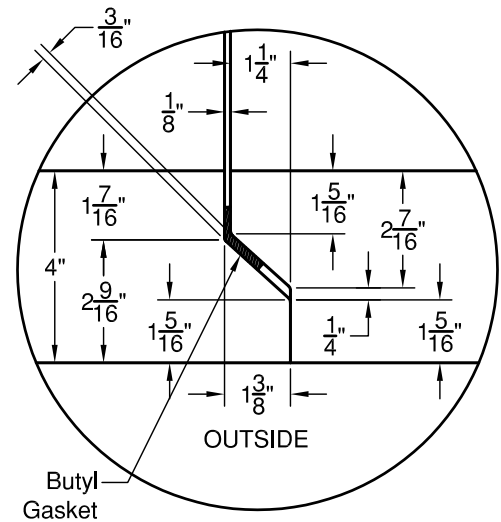

JOINT DETAIL

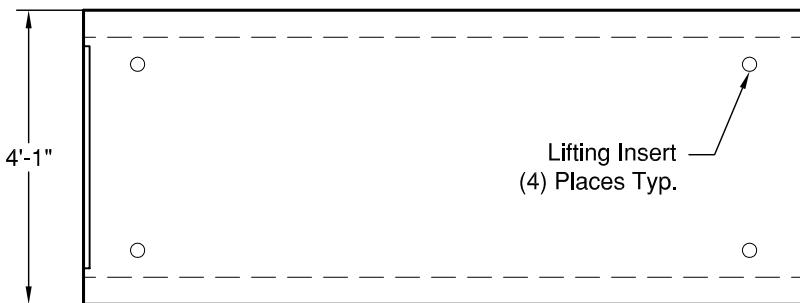

COVER

SPECIFICATIONS

1. Concrete: $F_c=4000$ psi @28 days
2. Rebar: ASTM A-615 Grade 60.
3. Design: ASTM C-857 "Minimum Structural Design Loading for Underground Precast Concrete Utility Structures".
4. Loads: AASHTO HS-20
5. Backfill with granular free draining material (sand or pea gravel) free of stones or cobbles greater than 4" in dia.
6. Items shown are subject to change without notice.