

# 4030 Precast Trench

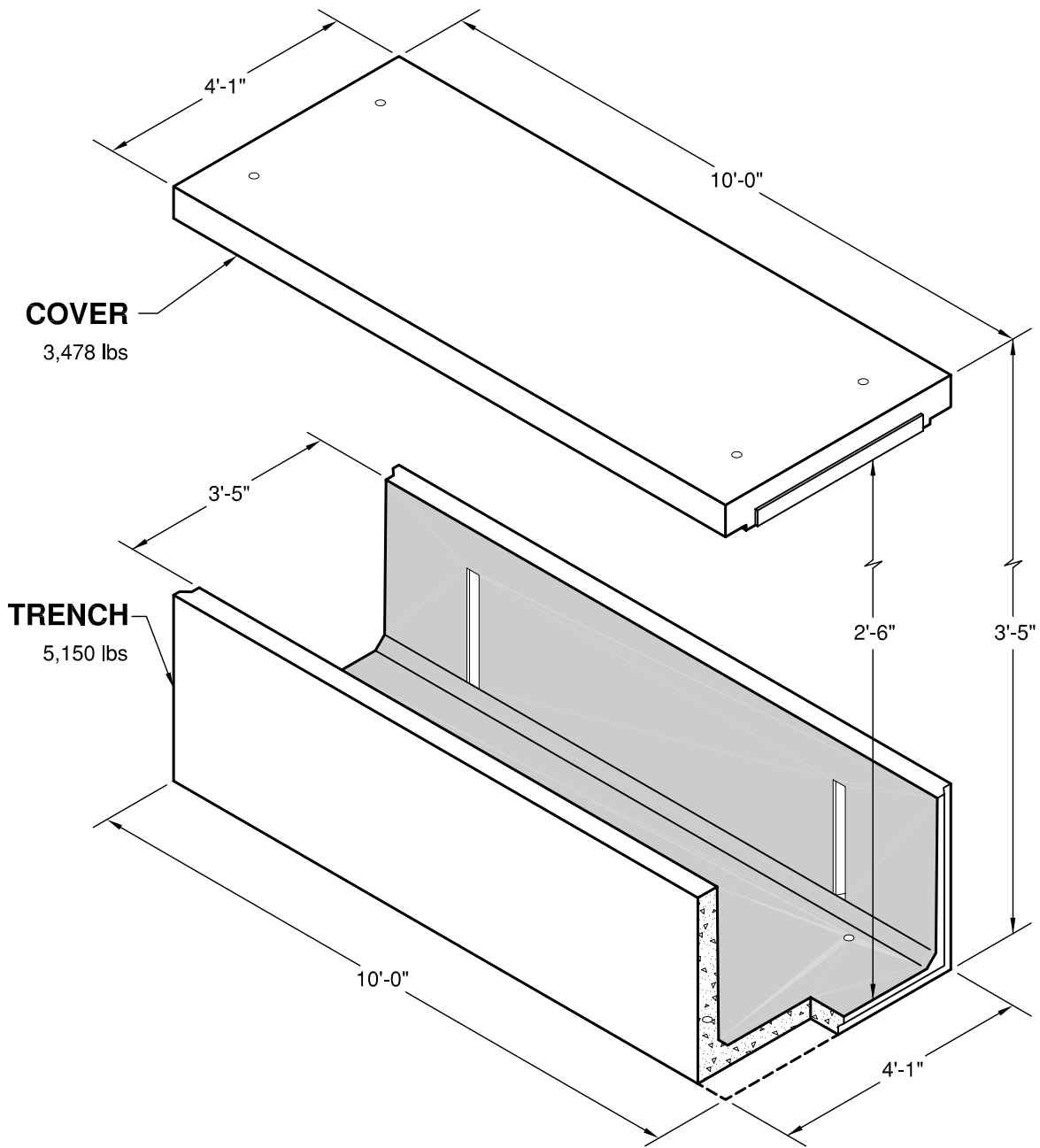

**GRANITE**

**PRECASTING &  
CONCRETE INC.**

# 4030 Precast Trench

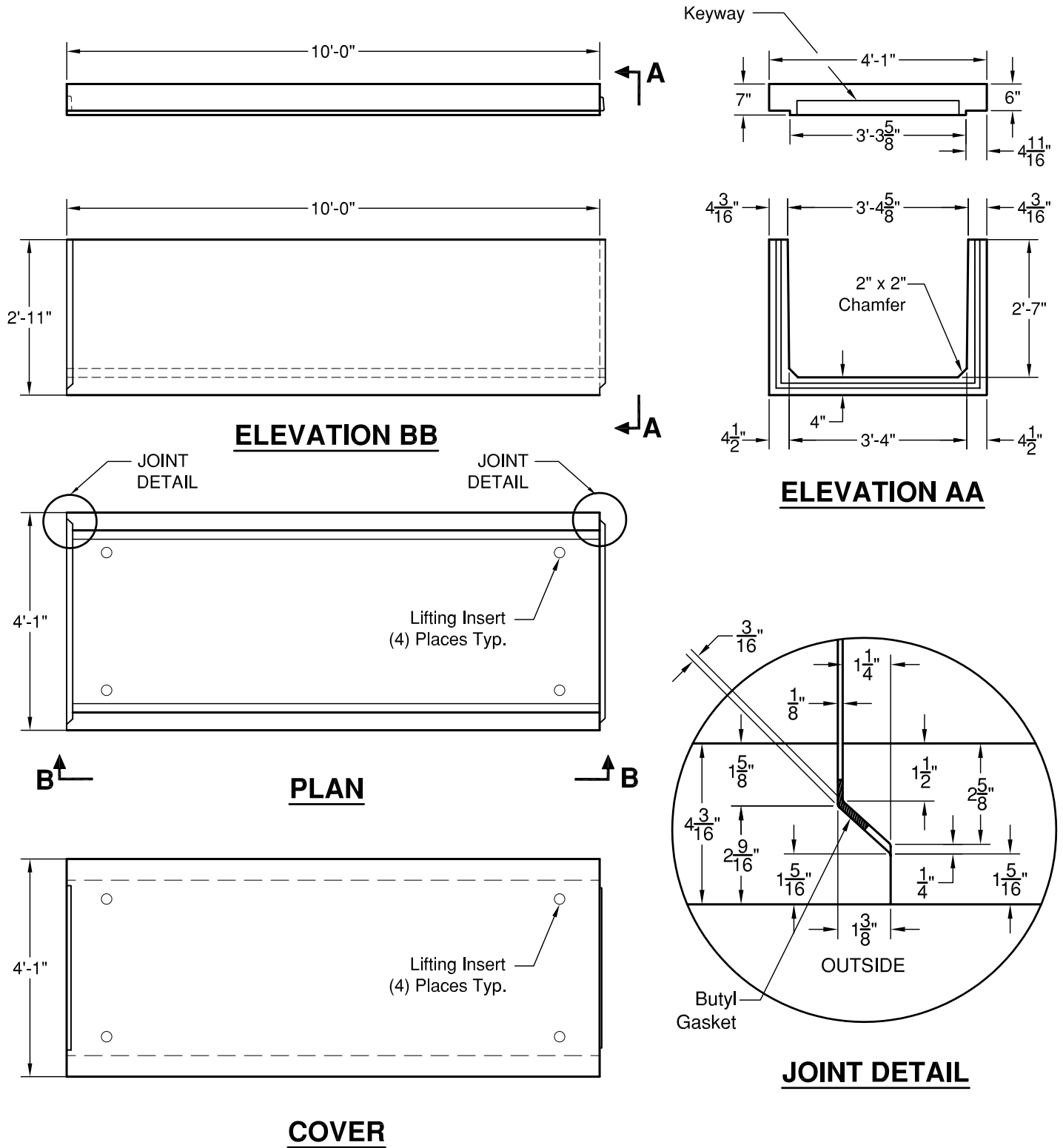

## SPECIFICATIONS

1. Concrete:  $F_c=4000$  psi @28 days
2. Rebar: ASTM A-615 Grade 60.
3. Design: ASTM C-857 "Minimum Structural Design Loading for Underground Precast Concrete Utility Structures".
4. Loads: AASHTO HS-20
5. Backfill with granular free draining material (sand or pea gravel) free of stones or cobbles greater than 4" in dia.
6. Items shown are subject to change without notice.