

4048 90° Precast Trench

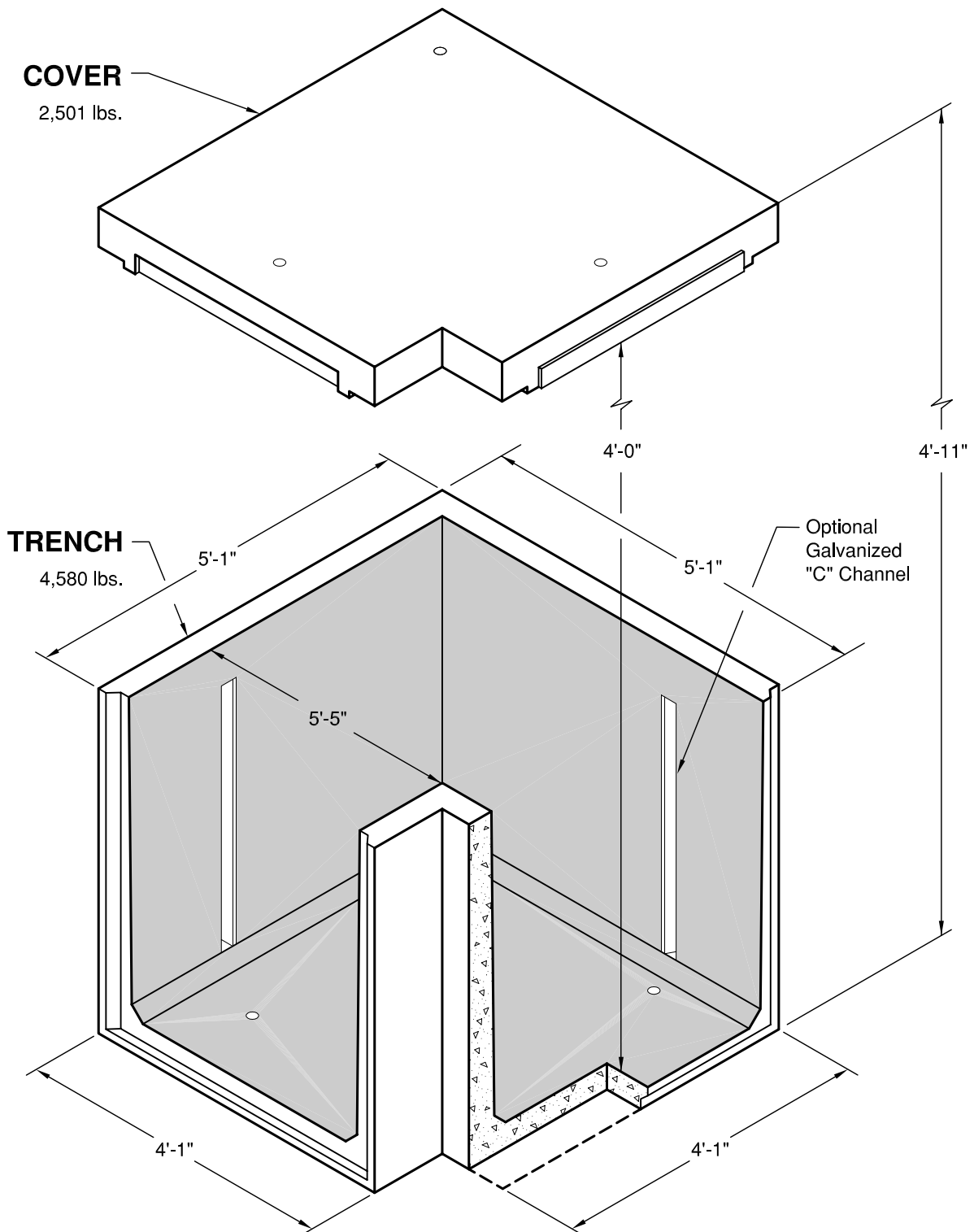

312



GRANITE

**PRECASTING &
CONCRETE INC.**

4116 BAKERVIEW SPUR • BELLINGHAM, WA 98226 • (360) 671-2251 • 1-800-808-2251 • FAX: (360) 671-0780

4048 90° Precast Trench

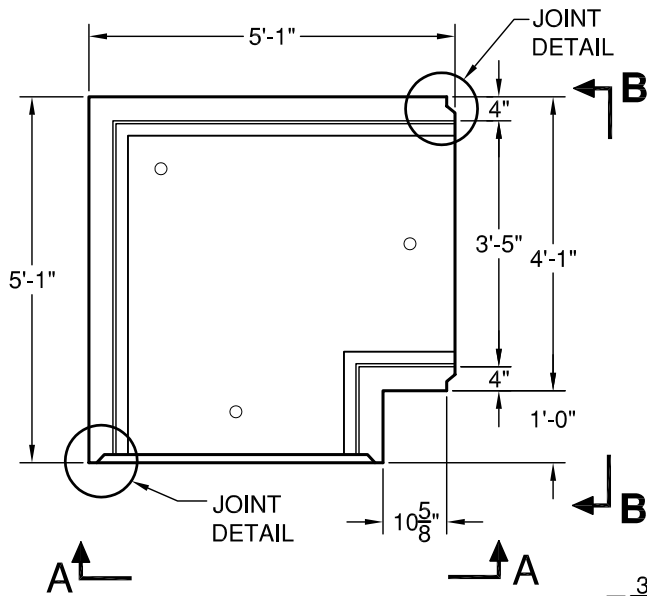

PLAN

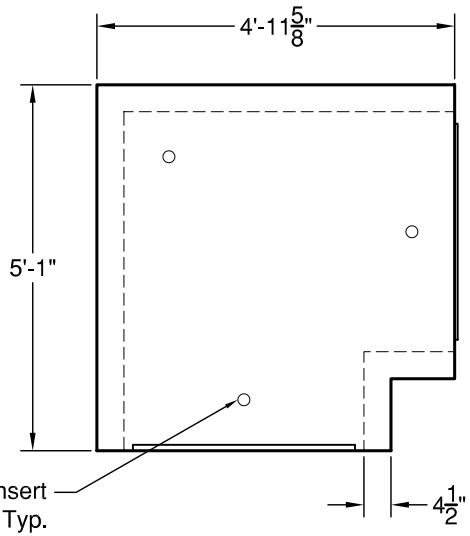

LID PLAN

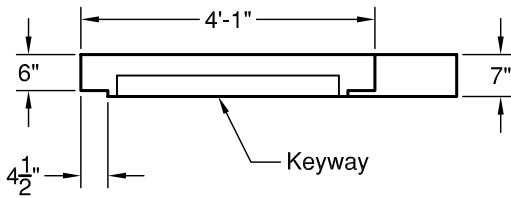

LID ELEV. AA

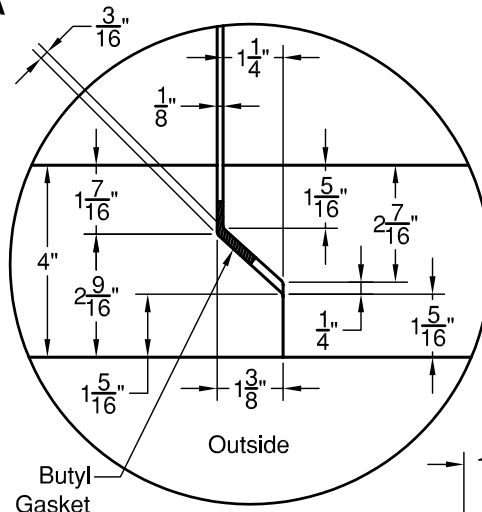

JOINT DETAIL

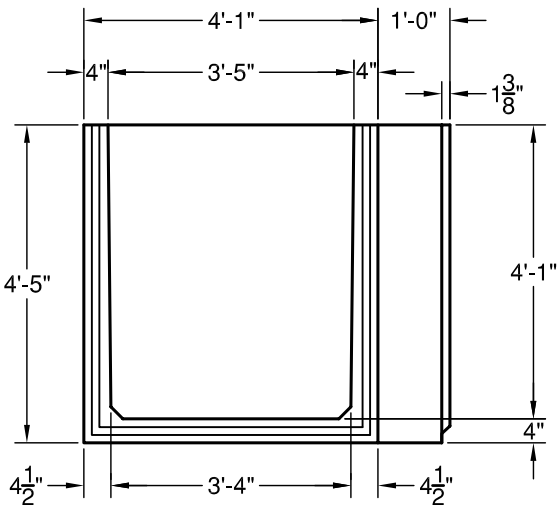

ELEVATION AA

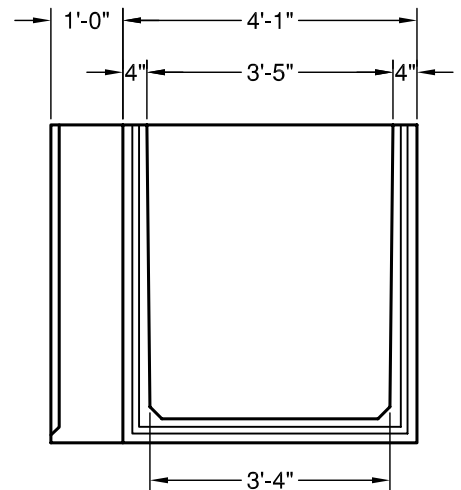

ELEVATION BB

SPECIFICATIONS

1. Concrete: $F_c=4000$ psi @28 days
2. Rebar: ASTM A-615 Grade 60.
3. Design: ASTM C-857 "Minimum Structural Design Loading for Underground Precast Concrete Utility Structures".
4. Loads: AASHTO HS-20
5. Backfill with granular free draining material (sand or pea gravel) free of stones or cobbles greater than 4" in dia.
6. Items shown are subject to change without notice.