

63 x 48 Precast Trench

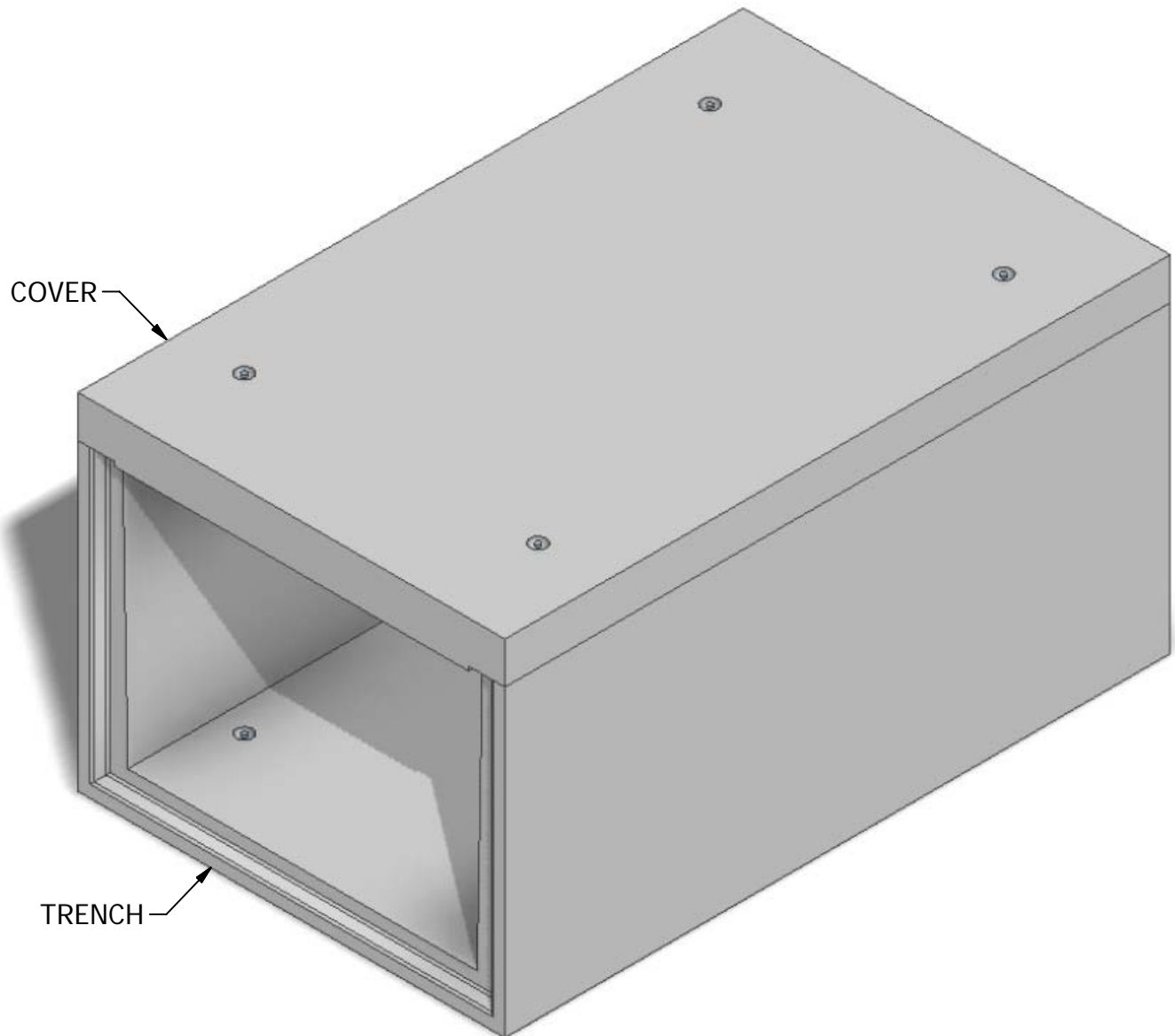

INTERIOR DIMENSIONS:
4'-0"H x 5'-3"W

WEIGHTS:
COVER (6,850 lbs)
TRENCH (12,200 lbs)

© 2011 Granite Precasting & Concrete, Inc.



GRANITETM

**PRECASTING &
CONCRETE INC.**

4116 BAKERVIEW SPUR • BELLINGHAM, WA. 98226 • (360) 671-2251 • 1-800-808-2251 • FAX: (360) 671-0780

63 x 48 Precast Trench

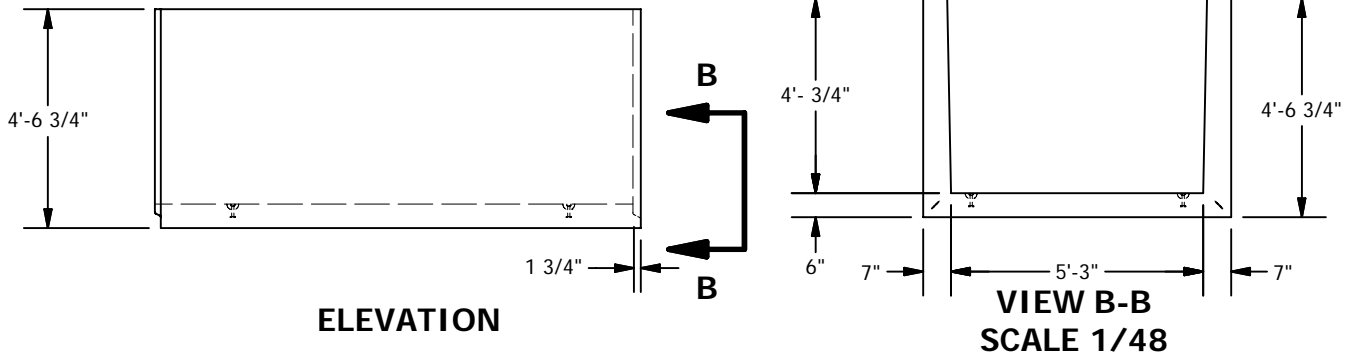
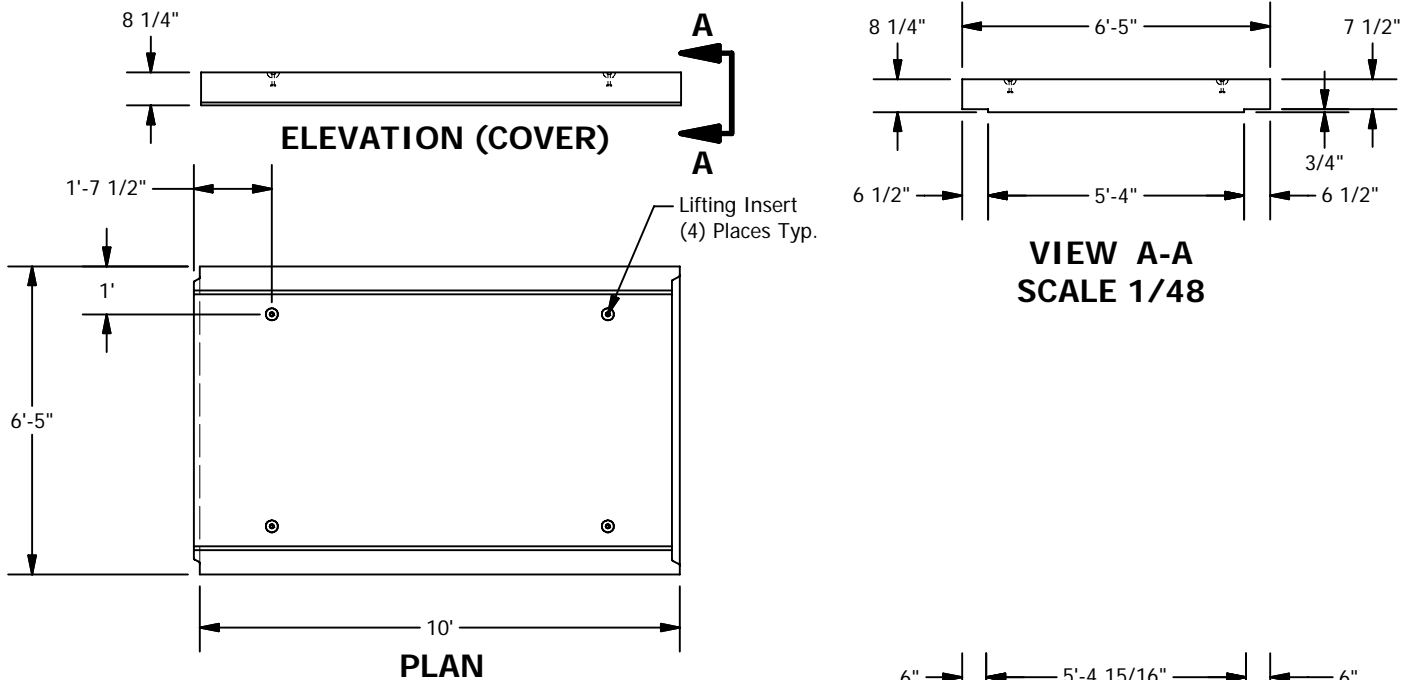
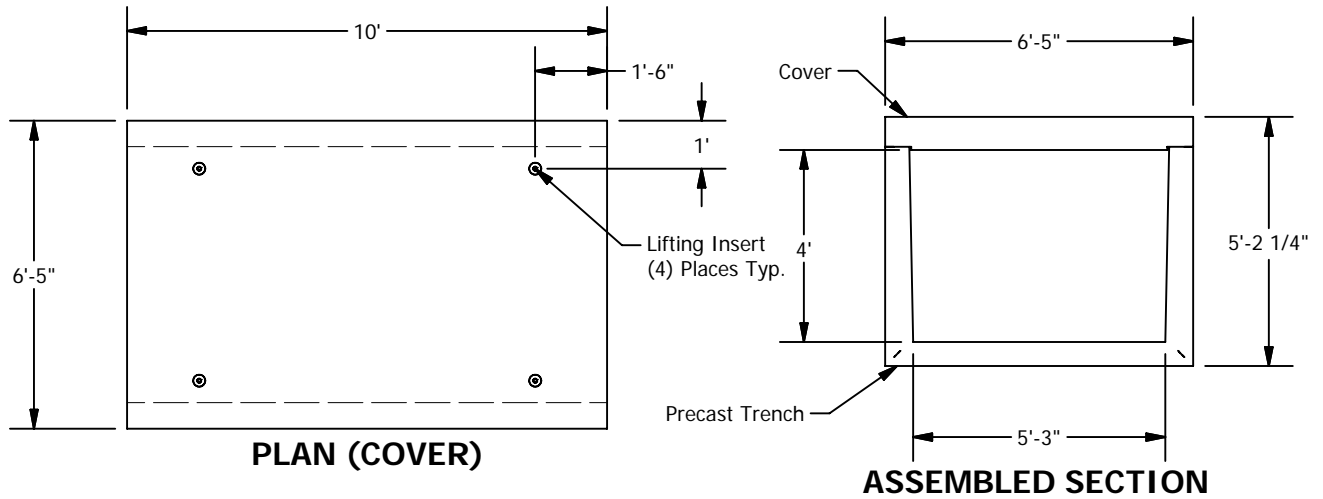

© 2011 Granite Precasting & Concrete, Inc.

SPECIFICATIONS

- Concrete: $F_c = 4,000$ psi @ 28 days
- Rebar: ASTM A-615 Grade 60
- Design: ASTM C-857 "Minimum Structural Design Loading for Underground Precast Concrete Utility Structures"
- Loads: AASHTO HS-20
- Backfill with granular free draining material (sand or pea gravel) free of stones or cobbles greater than 4" in dia.
- Items shown are subject to change without notice.