

8 x 8 Electrical Vault

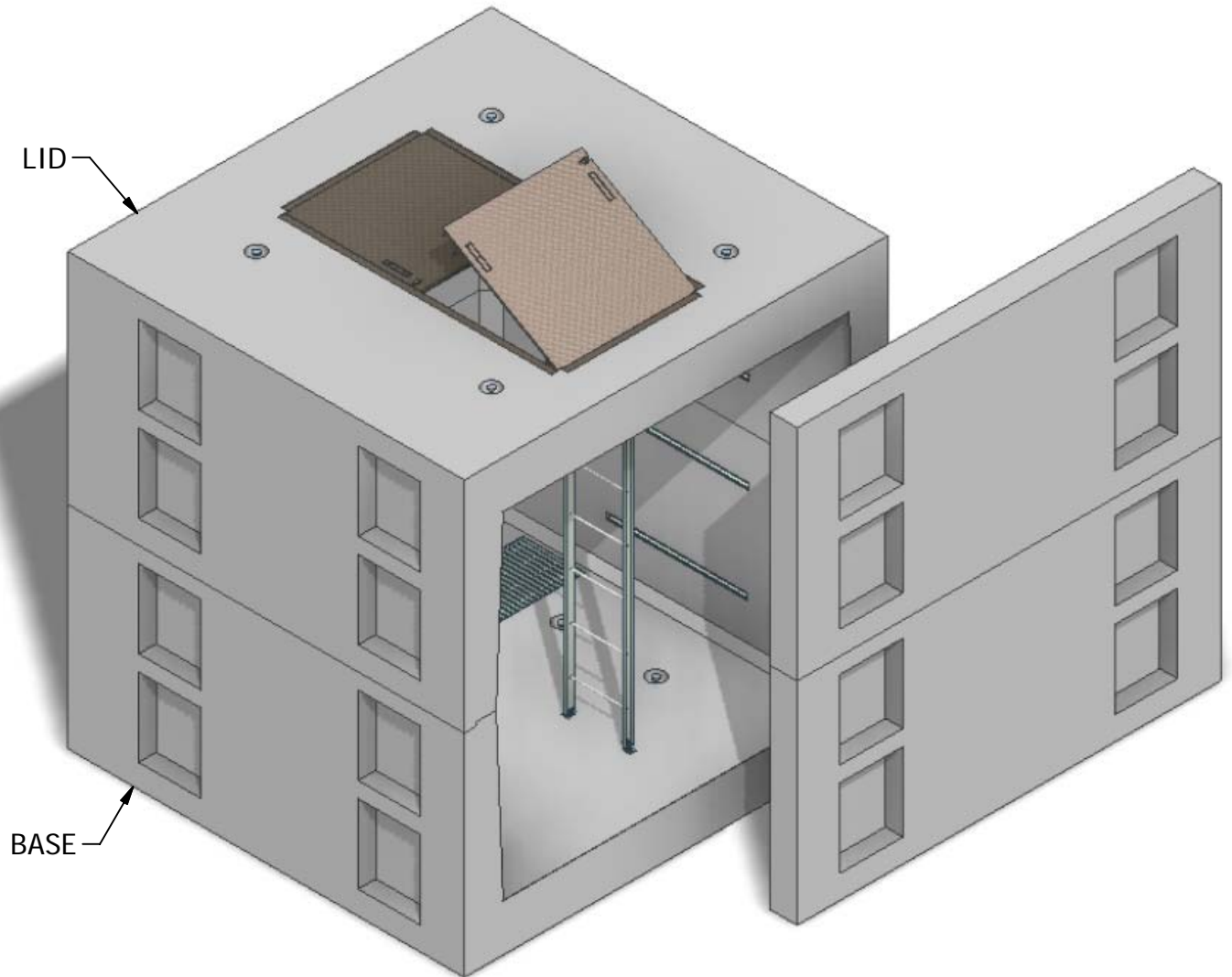

INTERIOR DIMENSIONS:
8'W x 8'L x 8'H

WEIGHTS:
LID (17,420 lbs)
BASE (18,440 lbs)

NOTE: Side panel has been shifted to show internal view and is not removable.

© 2011 Granite Precasting & Concrete, Inc.



GRANITETM

**PRECASTING &
CONCRETE INC.**

4116 BAKERVIEW SPUR • BELLINGHAM, WA. 98226 • (360) 671-2251 • 1-800-808-2251 • FAX: (360) 671-0780

8 x 8 Electrical Vault

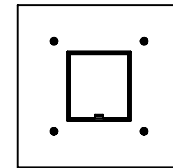
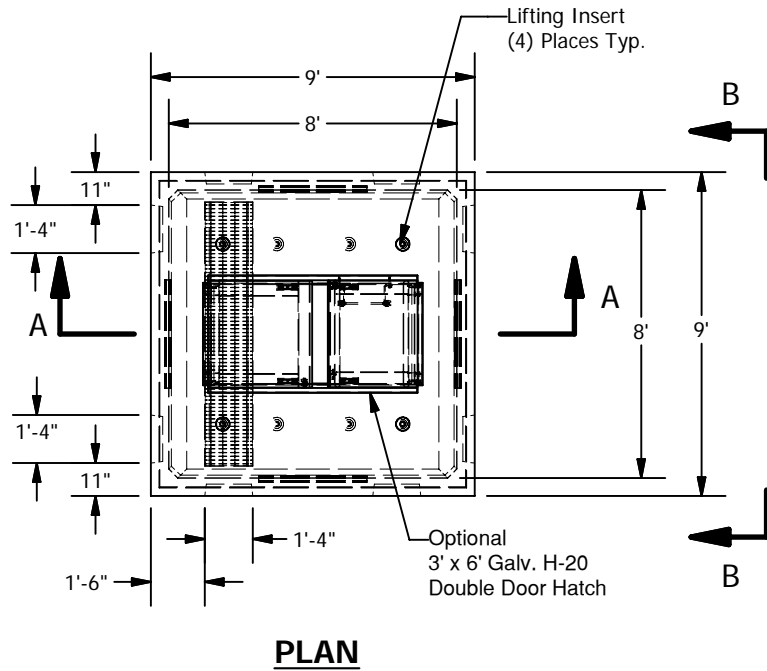

8' x 8' Lid
w/ 3' x 3' Hatch

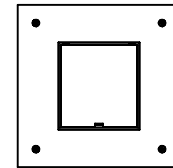

8' x 8' Lid
w/ 4' x 4' Hatch

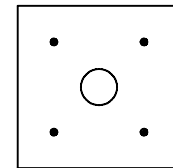

8' x 8' Lid
w/ 24", 30", 36",
42", or 48" Dia.
Opening

LID OPTIONS

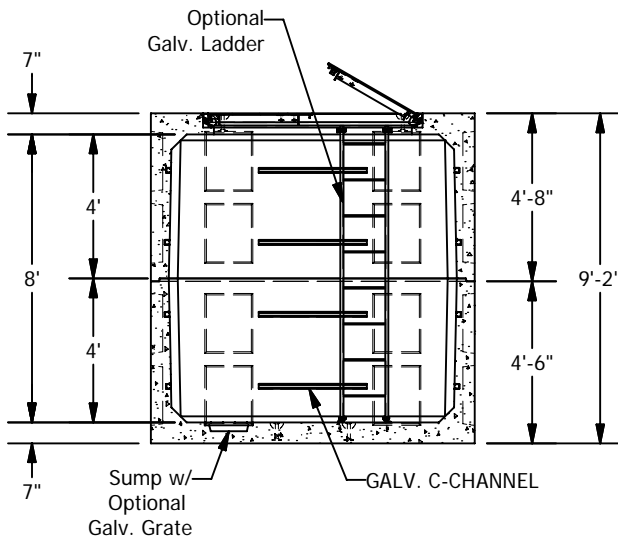

SECTION A-A

Knockout
1'-4" X 1'-8"
(8) per Side
(8) per End

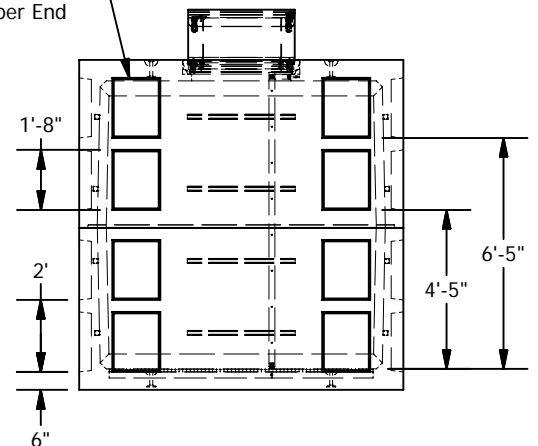

VIEW B-B

© 2011 Granite Precasting & Concrete, Inc.

SPECIFICATIONS

- Concrete: $F_c=5,000$ psi @28 days
- Rebar: ASTM A-615 Grade 60
- Design: ASTM C-857 "Minimum Structural Design Loading for Underground Precast Concrete Utility Structures"
- Loads: AASHTO HS-20
- Backfill with granular free draining material (sand or pea gravel) free of stones or cobbles greater than 4" in dia.
- Holes cored to plan specifications.
- Install lid prior to backfill.
- Items shown are subject to change without notice.