

8 x 12 Coalescing Separator 3

Projected Plate Area: 6,220 Sq/ft
Max. Process Flow Rate: 1,960 GPM

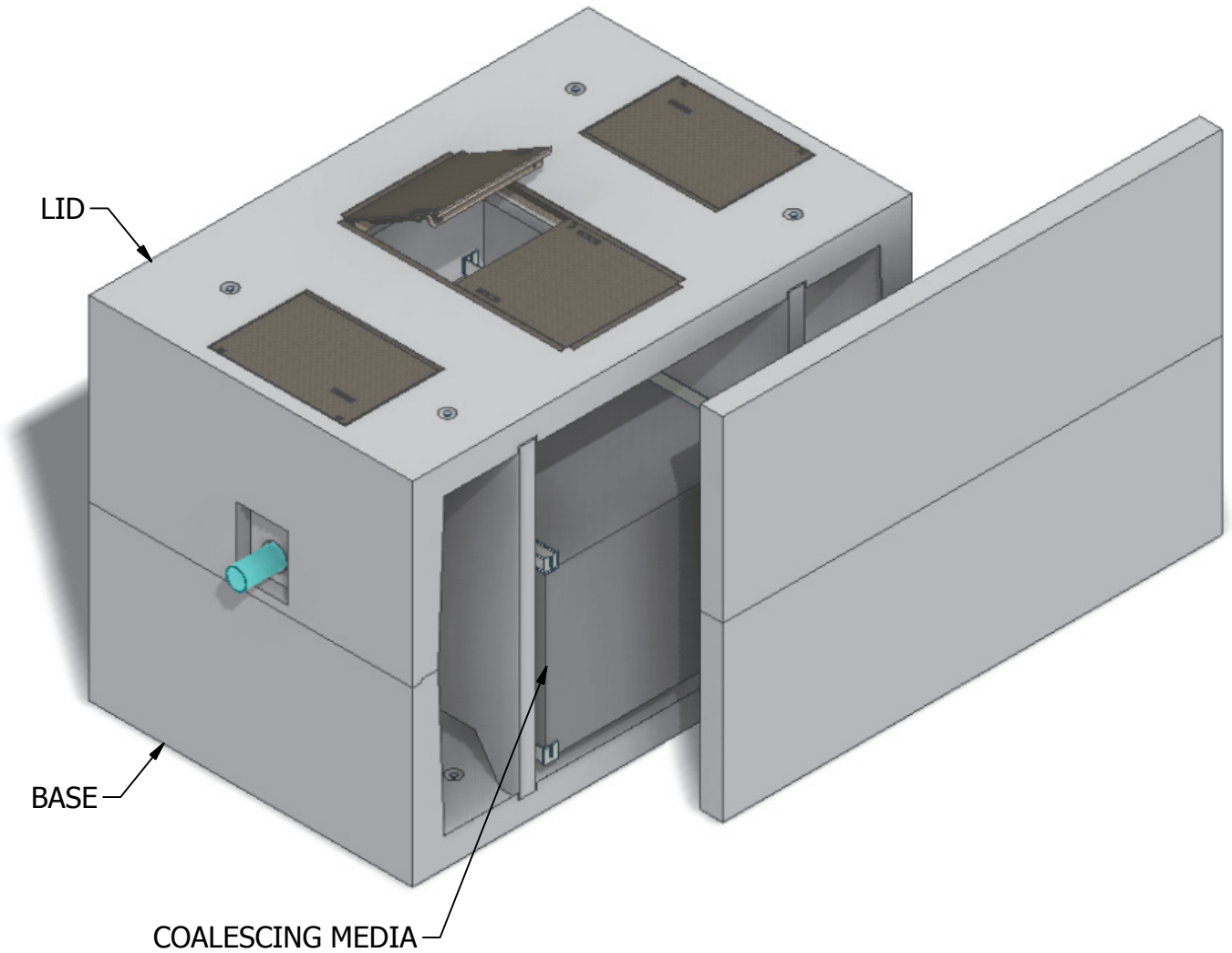

INTERIOR DIMENSIONS:
8'W x 12'L x 8'H

WEIGHTS:
LID (22,500 lbs)
BASE (32,240 lbs)

NOTE: Side panel has been shifted to show internal view and is not removable.

© 2013 Granite Precasting & Concrete, Inc.



4116 BAKERVIEW SPUR, BELLINGHAM, WA 98226 - (360) 671-2251 - 1-800-808-2251 - FAX: (360) 671-0780

8 x 12 Coalescing Separator 3

Projected Plate Area: 6,220 Sq/ft
Max. Process Flow Rate: 1,960 GPM

BASIC DESIGN INFORMATION

Design Flow = 1,560 GPM
Influent Oil Concentration = 100 ppm
Operating Temperature = 50 deg. F
Sized to Remove 60 micron and larger
Oil Specific Gravity = 0.88
Oil Rise Rate = 0.033 ft/min
Effluent Quality PPM
Designed per WA State Dept. of Ecology
"Volume V Runoff Treatment BMPs",
Chapter 11, August 2001

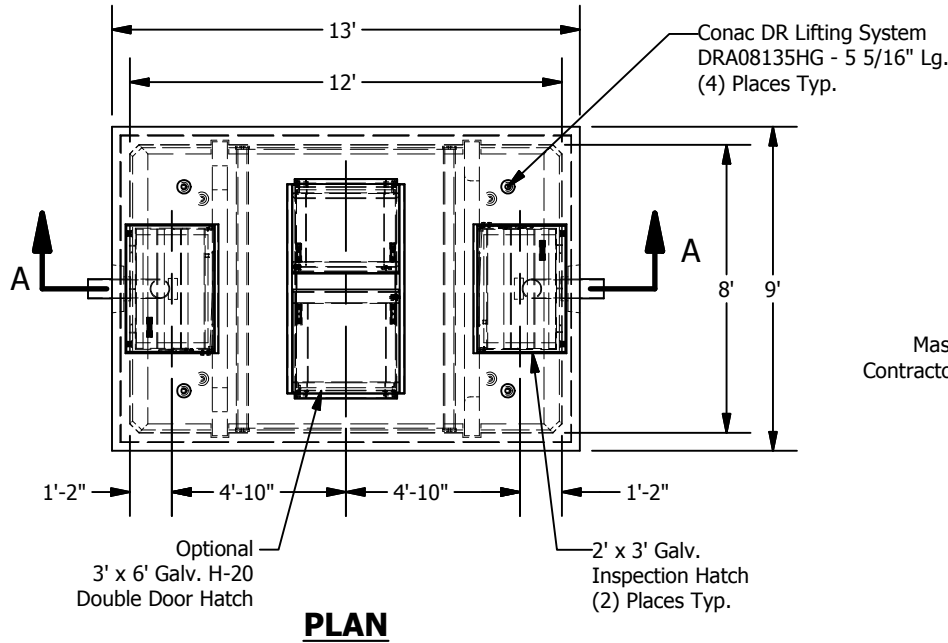

Mastic Joint Sealant
Contractor to Apply, Typ.

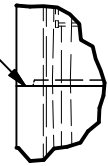

JOINT DETAIL D SCALE 1 / 32

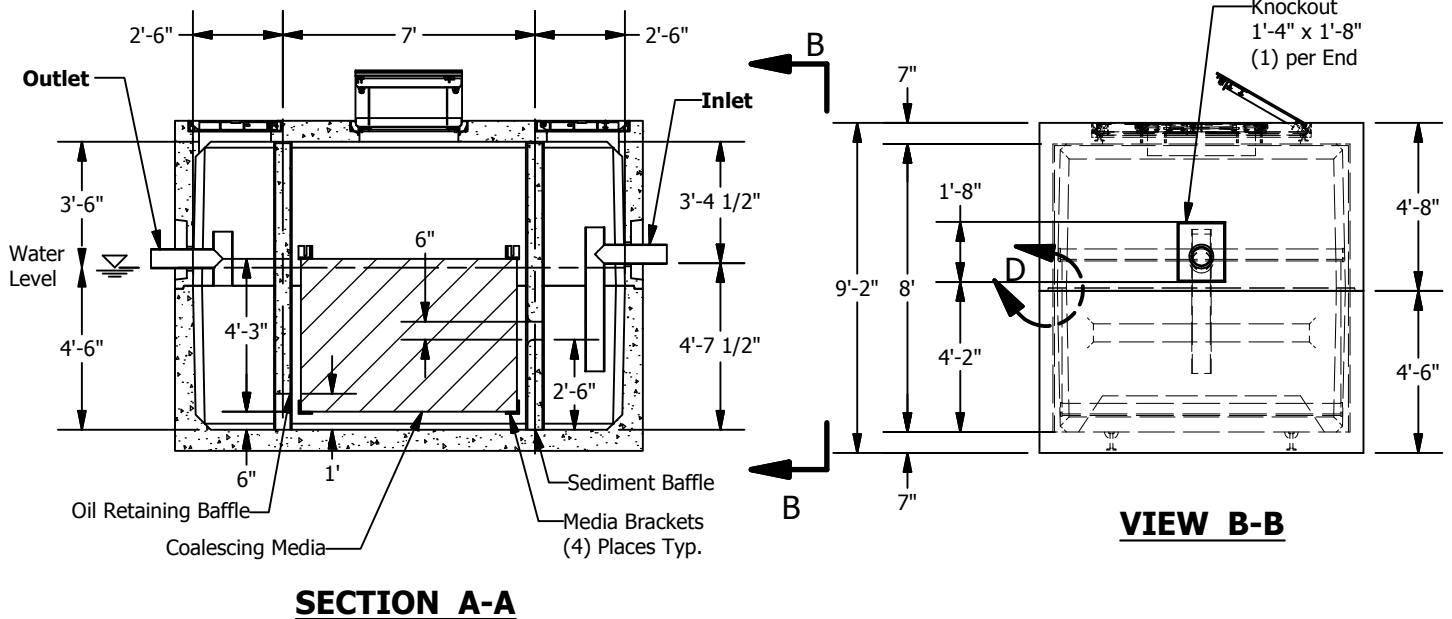

© 2013 Granite Precasting & Concrete, Inc.

SPECIFICATIONS

- Concrete: Fc=5,000 psi @ 28 days
- Rebar: ASTM A-615 Grade 60
- Design: ASTM C-857 "Minimum Structural Design Loading for Underground Precast Concrete Utility Structures"
- Loads: AASHTO HS-20
- Backfill with granular free draining material (sand or pea gravel) free of stones or cobbles greater than 4" dia.
- All pipe to be supplied and installed by contractor.
- Contractor to field install baffle.
- Fill with clean water prior to start up.
- Items shown are subject to change without notice.