

8 x 14 Grease Interceptor

5,100 Gallon
Capacity

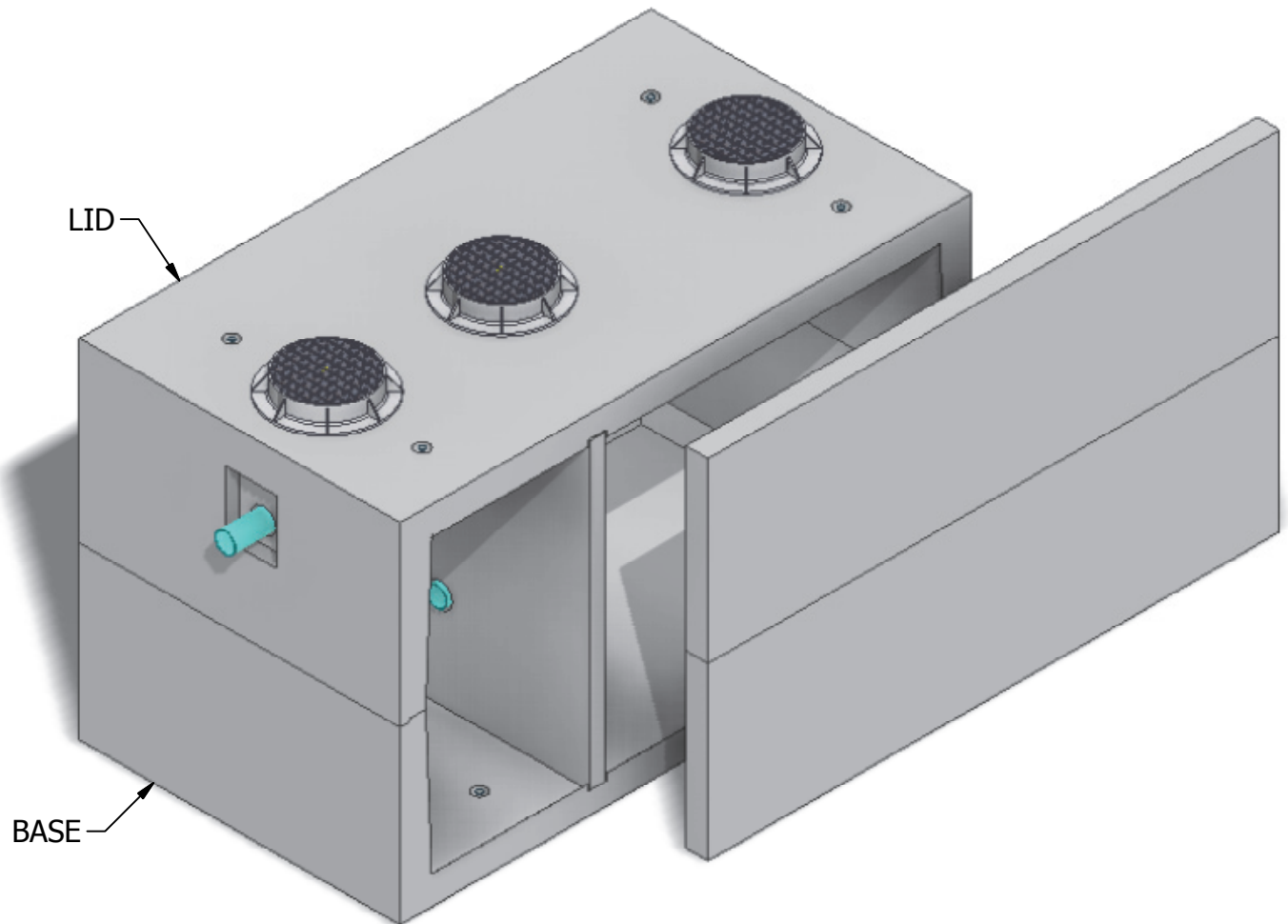

INTERIOR DIMENSIONS:
8'W x 14'L x 8'H

WEIGHTS:
LID (26,320 lbs)
BASE (31,140 lbs)

NOTE: Side panel has been shifted to show internal view and is not removable.

© 2013 Granite Precasting & Concrete, Inc.



4116 BAKERVIEW SPUR, BELLINGHAM, WA 98226 - (360) 671-2251 - 1-800-808-2251 - FAX: (360) 671-0780

8 x 14 Grease Interceptor

5,100 Gallon Capacity

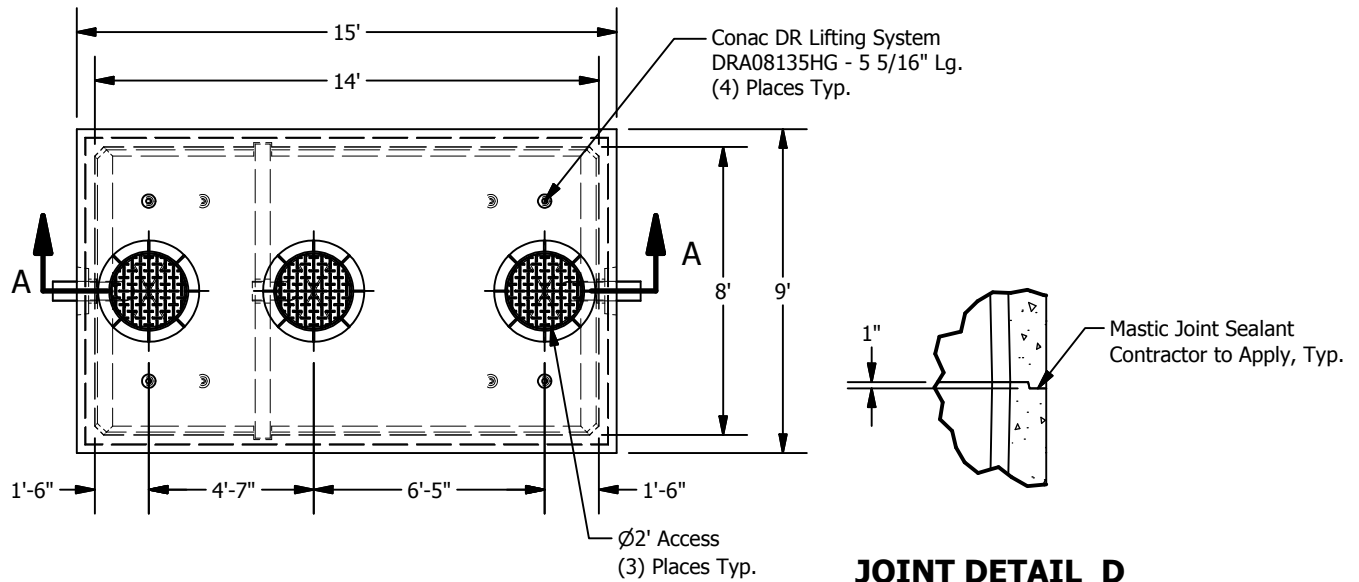

PLAN

JOINT DETAIL D
SCALE 1 / 32

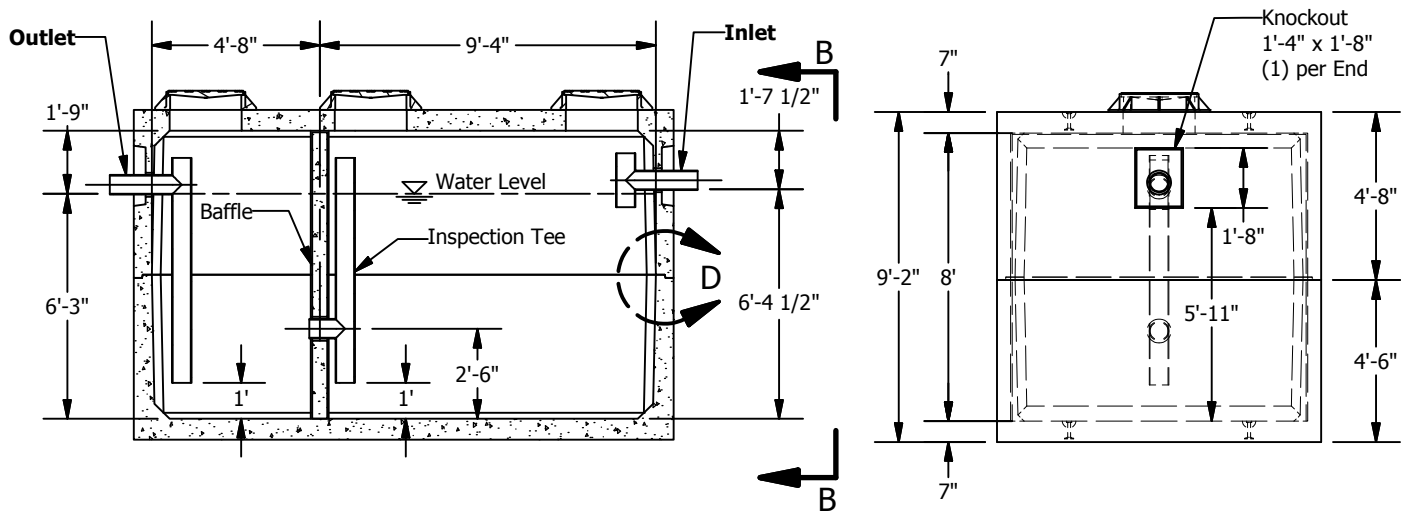

SECTION A-A

VIEW B-B

© 2013 Granite Precasting & Concrete, Inc.

SPECIFICATIONS

- Concrete: Fc=5,000 psi @ 28 days
- Rebar: ASTM A-615 Grade 60
- Design: ASTM C-857 "Minimum Structural Design Loading for Underground Precast Concrete Utility Structures"
- Loads: AASHTO HS-20
- Backfill with granular free draining material (sand or pea gravel) free of stones or cobbles greater than 4" dia.
- All pipe to be supplied and installed by contractor.
- Contractor to field install baffle.
- Fill with clean water prior to start up.
- Items shown are subject to change without notice.